

SINTEF Building and Infrastructure confirms that

Skado Medis Construction elements

has been found to be fit for use in Norway and to meet the provisions regarding product documentation given in the regulation relating to the marketing of products for construction works (DOK) and regulations on technical requirements for building works (TEK), with the properties, fields of application and conditions for use as stated in this document

1. Holder of the approval

UAB Skado Medis
 Pramonės g. 11
 LT-42150 Rokiskis
 Lithuania

2. Product description

2.1 General

Skado Medis Construction elements are factory produced timber frame elements for prefabricated walls, floor and roof elements based on wood. The elements are delivered from the factory completed. The elements are produced in lengths adapted to the individual house, and of up to 13,5 m and a maximum height of 2,95 m.

The elements are produced using standardized construction detailing such as described in this approval and are customized and manufactured for each individual building project. The approval document include the standard design of the structural components; walls, floor constructions and roof including joints between elements and connection to the foundation. Specifications of materials and components used in the modules are shown in Table 1.

The approval does not cover windows and doors and other supplementary building parts such as, stairs, balconies and technical installations like electrical systems, ventilation systems, sanitary equipment and roof drainage, which is designed especially for each building project.

2.2 Walls

Fig. 1- 4 show the principle designs of external and internal walls.

Fig. 2 shows the principle design of an internal wall load-bearing construction, fig. 3 show an internal non load-bearing wall construction. Fig 4 shows internal separating wall between housing units.

2.3. Floors/Slabs

Fig.5 shows the principle design of the standard slab construction. The beams are spaced c/c 600, with

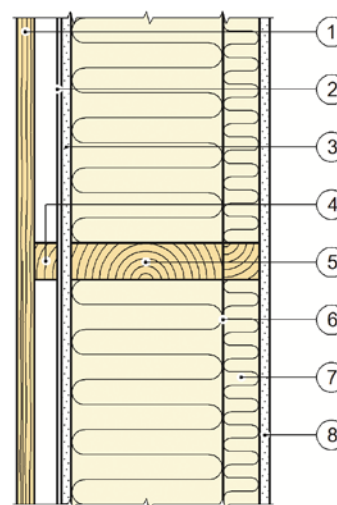

1	Horizontal exterior cladding	5	Stud, 45 mm x 195 mm c/c 600 mm + mineral wool, 200 mm
2	Wind-proof membrane	6	Vapour barrier
3	Exterior gypsum board, 9,5 mm	7	Battening, 45 mm x 42 mm c/c 600 mm + mineral wool, 50 mm
4	Battening, 20 mm x 42 mm c/c 600 mm	8	Gypsum board, 12,5 mm

Fig. 1
 Horizontal section showing the principle design of a standard external wall with horizontal wood cladding.

dimensions and spans according to SINTEF Building Research Design Guide 522.351.

2.4 Roof

Fig. 6 shows the principle design of the roof and fig. 7 shows the standard flat roof.

2.5 Construction details

Detailed module construction design and the principle design of module connections are described in "Standard Construction Details for Skado Medis Construction elements belonging to SINTEF Technical Approval No. 20482". The version of the construction details filed at SINTEF at any time is a formal part of the approval.

Table 1
Skado Medis Construction elements – Materials and component specifications

Material / component	Specification (Dimensions not specified in the table shall be as stated in the "Standard construction details" or according to design specifications worked out for each individual delivery or project)	CE-marking
Timber components		
Structural components	Structural graded timber according to EN 14081 with dimensions and strength class according to structural design. Steico I-joist according to ETA 06/0238 with dimensions and strength class according to structural design. Moisture content ≤ 18 %	X
Other timber components	Non-treated spruce or pine timber	
Sheathing		
Floor sheathing	22 mm Durelis Populaire or Forestia floor particleboard class P5 according to EN 13986 and	X
		X
Internal wall sheathing	12 mm Durelis Populaire floor particleboard class P5 according to EN 13986	X
External wall sheathing	9.5 mm Knauf gypsum boards, type E according to EN 520.	X
Thermal insulation materials		
Mineral wool	Isover glass wool according to EN 13162 with $\lambda_D = 0,037$ or $0,032$ W/mK and density > 13 kg/m ³ . (musts be specified on the drawings in case this is used different places.)	X
	Paroc Extra stone wool according to EN 13162 with $\lambda_D = 0,036$ W/mK	
Membranes and barriers		
Water vapour control layers	0,2 mm RaniMoBar polyethylene according to SINTEF Technical Approval 20201	X
Wind barrier	Siga Majvest according to SINTEF Technical Approval 20131	X
Pitched roof underlay	Siga Majcoat according to SINTEF Technical Approval 20131	X
Tape for membrane joints and window installation	Siga Wigluv and Corvum tape according to SINTEF Technical Approval 20134	
Claddings and linings		
External timber cladding	Min. 19 mm solid timber cladding according to EN 14519 / EN 15146 class A and SN/TS 3186	X
Internal lining	12.5 mm gypsum board, type A according to EN 520 Gypsum board type F, according to EN 520 with minimum density 800 kg/m ³	X
Fastener products		
Nails and screws	Nails and screws according to EN 14592. Type and dimensions for load bearing applications in accordance with individual structural design. Corrosion protection shall be equivalent to hot dip zinc coating according to EN ISO 1461 for exterior applications, and equivalent to zinc coating according to ISO 2081 for interior applications.	X

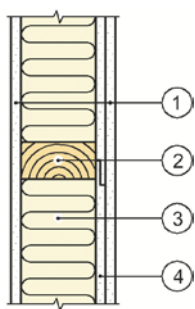

1	Gypsum board, 12,5 mm	3	Mineral wool, 150 mm
2	Stud, 45 mm x 145 mm c/c 600 mm	4	Chipboard 12 mm

Fig.2. Shows the principle design of standard internal load-bearing wall

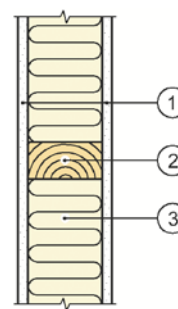

1	Gypsum board, 12,5 mm	3	Mineral wool, 100 mm
2	Stud, 45 mm x 95 mm c/c 600 mm		

Fig.3. Show the principle design of standard internal non load-bearing wall

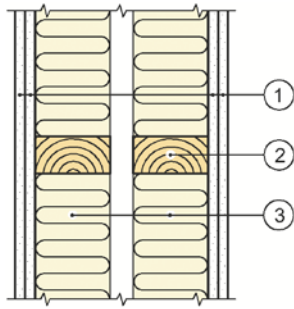

1	Gypsum board, 2x 12,5 mm	3	Mineral wool, 100 mm
2	Stud, 45 mm x 95 mm c/c 600 mm		

Fig.4 Principle design of standard internal fire resistance wall

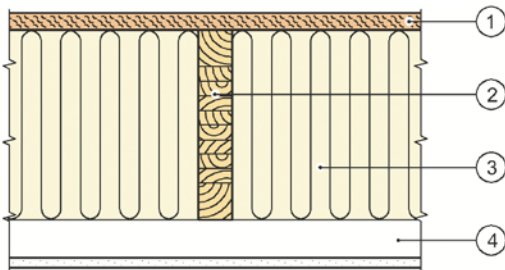

1	Chipboard / floorboard, 22 mm	3	Mineral wool, 200 mm
2	Construction beams, 45 mm x 195 c/c 600 mm	4	Wood laths, 33 mm x 42 mm c/c 400

Fig.5. Principle design of standard slab construction

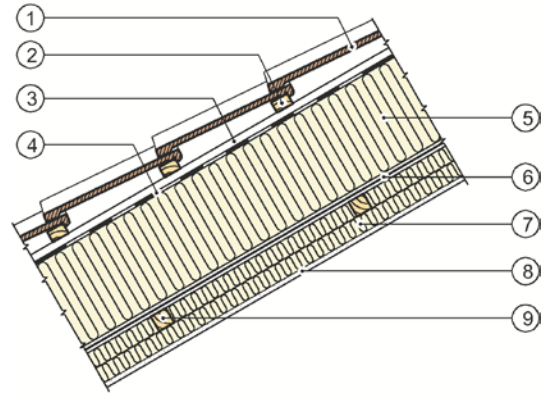

1	Roof tiles ¹⁾	6	Vapour barrier
2	Wood laths, 42 mm x 45 mm c/c 300 impregnated	7	Battening, 45 mm x 42 mm c/c 400 mm mineral wool, 50 mm
3	Wood laths, 20 mm x 42 mm c/c 600 impregnated	8	Gypsum board, 12,5 mm
4	Roof underlay 170 g/m ²	9	Battening, 45 mm x 42 mm c/c 600 mm mineral wool, 50 mm
5	Rafters, 45 mm x 250 mm c/c 600 mm mineral wool, 250 mm		

¹⁾ Not included in the approval

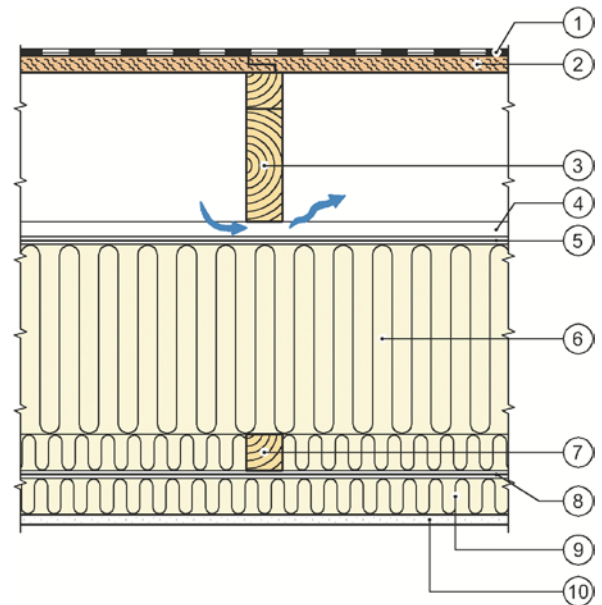

1	Two Layer Bitumen waterproofing	6	Rafters, 45 mm x 250 mm c/c 600 mm mineral wool, 250 mm
2	Chipboard, 22 mm	7	Battening, 45 mm x 42 mm c/c 400 mm mineral wool, 50 mm
3	Impregnated rafters 45 mm x 145 / 195 mm, for slope	8	Vapour barrier
4	Wood laths, 20 mm x 42 mm c/c 600 impregnated	9	Battening, 45 mm x 42 mm c/c 600 mm mineral wool, 50 mm
5	Diffusive membrane 170 g/m ²	10	Gypsum board, 12,5 mm

Fig. 6 Principle design of standard roof construction

Table 2
Skado Medis Construction elements – Fire resistance

Buildingpart	Fire resistance equivalent to
External wall See fig. 1	REI 30 ¹⁾
Internal load-bearing wall See fig.2	REI 30 ²⁾
Separating wall between housing units See fig. 4 (stone wool)	REI 30 ²⁾
Standard slab construction See fig. 5	REI 30 ³⁾
Standard roof construction. See fig. 6	REI 30 ³⁾
Standard flat roof construction. See fig. 7	REI 30 ³⁾

¹⁾ One sided fire exposure from the inside

²⁾ One sided fire exposure

³⁾ One sided fire exposure from underneath

3. Fields of application

Skado Medis Construction elements can be used in assembling single occupancy houses in two stories, restricted to fire class of 1 according to the provisions of the Regulation on technical requirements for building works (TEK).

The layout and building size is determined and designed for each individual project, in accordance with the case to case design of structural capacity and resistance to fire. The elements may also be used for other type of buildings, providing the performance requirements for the building are assessed in relation to the declared performance of the modules.

4. Properties

4.1 Load-carrying capacity

The mechanical resistance and stability of all structural components are calculated in full for each building project. Each element is dimensioned using NS-EN 1995-1-1 with national annex NA, and NS-EN 1991-1-1, 3 and 4 with national annexes NA for imposed loads, snow loads and wind loads.

For ordinary low rise houses with one or two stories the horizontal racking resistance may be regarded as acceptable without additional structural design calculations.

4.2 Fire resistance

Fire resistance as given in table 2 may be applied for the module constructions with minimum material, component dimensions and mechanical fasteners as specified in chap. 3 and in "Standard Construction Details".

The structural capacity of load-bearing elements in fire situation must be calculated for each individual project according to NS-EN 1995-1-2 with national annex NA. The load-bearing capacity for the given fire exposure time must be checked against the design load for each specific project according to relevant parts of NS-EN 1991.

4.3 Reaction to fire

Gypsum board internal lining is classified as A2-s1, d0 according to EN 13501-1.

External wood cladding is classified as D-s2, d0 according to EN 13501-1.

Mineral wool shall be class A1 according to EN 13501-1.

Roofing shall be class B_{ROOF}(t2) if no other requirement follows from the guidance to TEK10.

4.4 Thermal insulation

Table 3 shows thermal transmittance values, U-values, for standard elements described in chapter 2. Thermal loss due to extra timber used around door- and window openings, are not included.

Thermal transmittance for roof constructions installed on top of the modules is calculated case by case in full for each building project.

Table 3
Thermal transmittance, U-value

Structure	Total thermal insulation thickness mm	U-value W/m ² K
External walls according to fig. 1	240	0,18
Roof according to fig. 5 and 6	340	0,12

4.5 Sound insulation

With separating wall design, and construction details and connections as described in chap. 2, the sound insulation properties in accordance with NS-EN ISO 16283-1 as well as NS-EN ISO 717-1, are estimated to be as indicated in Table 4 for completed house constructions. This corresponds to sound insulation class C in accordance with NS 8175 for residential houses. The sound insulation performance depends also on the installation of pipes, ducts and cables for each individual building, which has to be assessed case by case.

Table 4
Estimated sound insulation performance in completed houses

Structure	Estimated, weighted apparent sound reduction index R' _w	Estimated weighted normalised impact sound pressure level L' _{n,w}
Separating walls between apartments	≥ 55 dB	-

No sound insulation performance has been determined for the external walls and roof constructions.

5. Environmental aspects

5.1 Substances hazardous to health and environment

The products contain no hazardous substances with priority in quantities that pose any increased risk for human health and environment. Chemicals with priority include CMR, PBT or vPvB substances.

5.2 Effect on indoor environment

The product is not regarded as emitting any particles, gases or radiation that have a perceptible impact on the indoor climate, or to have any significant impact on health.

5.3 Effect on soil, surface water and ground water

The leaching properties of the product are evaluated to have no negative effects on soil or ground water.

5.4 Handling of waste

The product shall be sorted as wood, metal, gypsum, residual waste or other appropriate waste fractions on the building/demolition site. The product shall be delivered to an authorized waste treatment plant for material recovery, energy recovery or disposal.

5.5 Environmental product declaration

No environmental declaration (EPD) has been worked out for the product.

6. Special conditions for use and installation

6.1 Design considerations in general

The production and delivery of elements is based on a structural design fulfilling requirements for fire resistance, and thermal insulation for each individual building. The requirements and necessary design calculations shall be available before production and deliverance of the elements.

6.2 Structural design

The production of each building is based on a full structural design for floors construction, load-bearing walls and roof.

The structural design of the building includes vertical and horizontal load capacity, anchoring to the foundations, wind anchoring and the roof structure, beams over structural wall openings.

6.3 Fire resistance design

The production of each element shall be based on a full structural fire design applicable to the overall fire design requirements for the complete building. This includes all fire resistance performance not covered by the performance listed in chapter 4.2 and table 2.

6.4 Thermal insulation design

For each project using elements according to this approval, the design and production shall be based on the required maximum thermal resistance and transmittance for the complete building.

6.5 Foundations

The elements shall be installed on foundations designed according to the principles shown in SINTEF Building Research Design Guide 521.203. Moisture transport from the foundation to the building elements shall be prevented by a capillary breaking layer. The modules shall be installed on a foundation which satisfies the manufacturer's requirements regarding dimensions and level tolerances.

6.6 Installation in general

The modules shall be installed and connected according to the details shown in "Standard Construction Details for Skado Medis Construction modules belonging to SINTEF Technical Approval No. 20482

Installation of ducts, pipes and cables for technical services, including special installation shafts, shall be sealed at every penetration of building structures according to specifications worked out for each particular project. The sealing shall provide necessary fire resistance performance if required.

6.7 Transport and storage

The elements shall be protected from precipitation during transportation and storage using watertight materials. Before and during assembly of elements to a building, the elements must be stored in a dry environment and protected from precipitation.

7. Factory production control

The product is produced by

UAB Skado Medis
Promones g. 6
LT-42150 Rokiskis
Lithuania

The holder of the approval is responsible for the factory production control in order to ensure that the product is produced in accordance with the preconditions applying to this approval.

The manufacturing of the product is subject to continuous surveillance of the factory production control in accordance with the contract regarding SINTEF Technical Approval.

8. Basis for the approval

The approval is based on an assessment of the standard construction details, and the verification of construction performances according to the following documents:

- SINTEF Building Research Design Guides No. 471.011 (thermal insulation, slab)
- SINTEF Building Research Design Guides No. 471.013 (thermal insulation, roof)
- SINTEF Building Research Design Guides No. 471.401 (thermal insulation, wall)
- SINTEF Building Research Design Guides No. 520.308 (fire resistance)
- SINTEF Building Research Design Guides No. 520.321 (fire resistance)
- SINTEF Building Research Design Guides No. 520.322 (fire resistance)
- SINTEF Building Research Design Guides No. 522.351 (floor construction)

9. Marking

Each delivery must be accompanied by documents comprising as a minimum the manufacturer's name and address, project identification, time and date of manufacture, assembly instructions, as well as specific construction details and assembly instructions that comply with the "*Standard construction details for Skado Medis*

Construction Building System belonging to SINTEF Technical Approval TG 20482".

The approval mark for SINTEF Technical Approval No. 20482 may also be used.



Approval mark

10. Liability

The holder/manufacturer has sole product responsibility according to existing law. Claims resulting from the use of the product cannot be brought against SINTEF beyond the provisions of Norwegian Standard NS 8402.

for SINTEF Byggforsk

Hans Boye Skogstad
Godkjenningsleder